

Simple Touch® 15-Channel Remote Cellular Shades

- Installation and Care Instruction

Installation

1. Identify your cellular shade and parts (your parts may vary, depending on the custom request & size of the shade you are purchasing.)

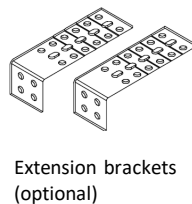
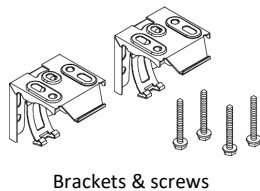
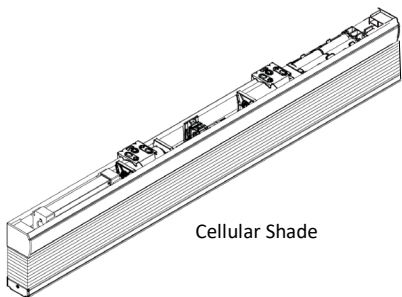

2. Tools you may need (not included)

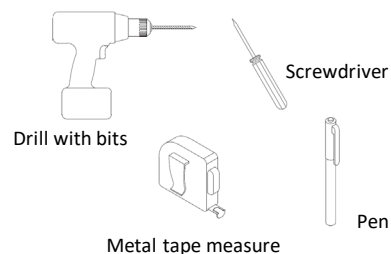

3. Install the brackets

- Mark the bracket locations. Space the brackets evenly and make sure the brackets will not interfere with any mechanism or other internal headrail parts.
- Install the brackets using screws (included) and tighten them completely.
- Make sure all brackets are aligned and level with each other.
- Install the shade with extension brackets (optional)
 - Install the extension bracket with at least 2 screws.
 - Attach the hidden brackets to the extension brackets with the screws.

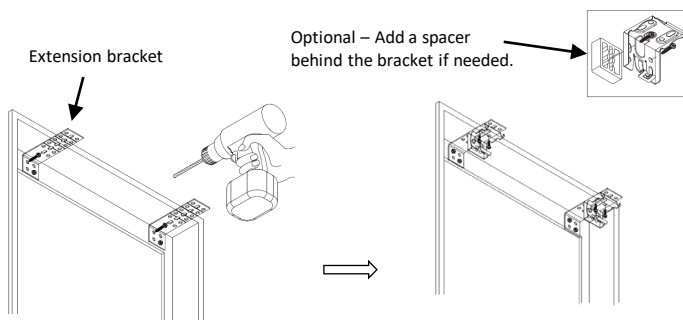
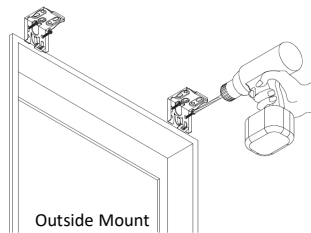
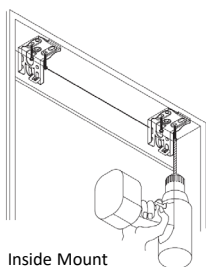

4. Put 8 Lithium AA batteries inside the battery box.

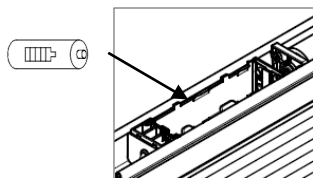

5. Mount the shade onto the brackets

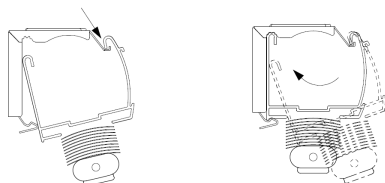

6. Change the batteries.

Remove the shade from the brackets. Replace with new batteries (do not mix new batteries with used batteries). Mount the shade.

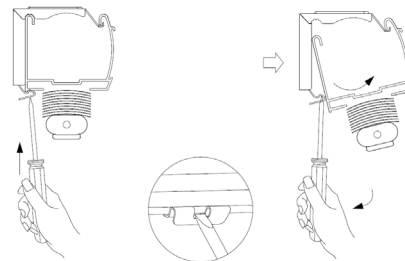

Care and Clean

- Wipe the shade periodically with a soft dust cloth or dusting mitt, or vacuum with a lowest speed.

Notes

- Do not spill water to the headrail and the remote.
- Do not clean/ operate the motorized shade with wet hands
- The warranty for your shades does not cover damage caused by improper cleaning.
- Changing the batteries won't change the programming setting.



ID# 2AWSE-STP017WR15

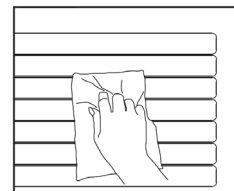

Simple Touch® 15-Channel Remote Cellular Shade

- Operation and Programming



This Simple Touch® motorized shade is already connected to the remote and programmed with Upper and Lower Limits. Option to program "My Favorite Position", follow the instruction below. Enjoy your new motorized shade!

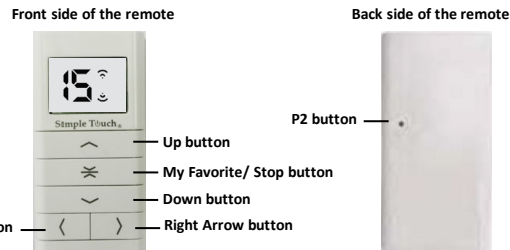

Features and Operation

FEATURES

- This motorized cell shade is operated by a 15-channel remote.
- Each channel can only control **ONE** motorized shade.
- Channel "0" is designed to control the multiple shades. The maximum controlled quantity is 15 shades.

OPERATION

- Click the **Left Arrow** () and **Right Arrow** () buttons to switch within channels.
- **Before set up My Favorite Position**
 - Press the **Up** () or **Down** () buttons to control the bottom rail go up or go down.
 - Click the **My Favorite/ Stop** () buttons to stop the moving of the shade.
- **After set up My Favorite Position** (please refer to the programming instruction below)
 - Press the **My Favorite** () button for 2 ~ 3 seconds and then release the button. The shade will go to My Favorite Position.
 - Press the **Up** () or **Down** () buttons for 1.5 seconds and then release the buttons. The shade will continue going up or going down.
 - Click the **My Favorite/ Stop** () button to stop the moving of the shade.

Programming Instruction (optional setup)

PROGRAMMING FOR MY FAVORITE POSITION

Set Up My Favorite Position



- Step 1. Click the **Right Arrow** or **Left Arrow** buttons to select the channel. If you only have shade, please stay with channel "1".
 - Step 2. Control the bottom rail to the favorite position by pressing the **Up** or **Down** buttons.
 - Step 3. Press **My Favorite** button for 5 seconds or until you hear a short "B".
 - Step 4. Then press **My Favorite** button again for 3 seconds or until you hear 3 short "B".
- My Favorite Position** set up is done.

ADDING A DUPLICATED REMOTE CONTROL

Add A Duplicated Remote Control

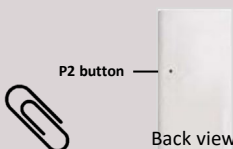

- Step 1. Click the **Right Arrow** or **Left Arrow** buttons to select the motorized shade you want to copy.
- Step 2. Click **P2** button with a paper clip or other small items on the back of the existing remote once. Then the shade **jogs** once.

NOTE. DO NOT USE A PIN OR A NEEDLE TO PRESS THE P2 BUTTON. IT MAY DAMAGE THE P2 BUTTON.
- Step 3. Click the same **P2** button again, and then shade **jogs** once. Continue to next page.

Simple Touch® 15-Channel Remote Cellular Shade

ADDING A DUPLICATED REMOTE CONTROL (continued)

Step 4. Click the **P2** button on the new remote, and then shade **jogs** once.

Adding a duplicated remote control is done.

NOTE - GO TO EACH CHANNEL TO ADD THE DUPLICATED REMOTE WHEN YOU HAVE MULTIPLE SHADES YOU WANT TO COPY.

DELETING A DUPLICATED REMOTE CONTROL

Delete A Duplicated Remote Control

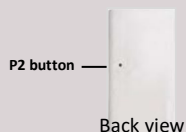

Step 1. Click the **P2** once on the remote you want to keep. Wait for the shade to "**jog**".

Step 2. Click the same **P2** button again, and then wait for another **jog**.

Step 3. Click the **P2** button on the remote you want to delete.

Deleting a duplicated remote control is done.

TO HIDE AND UNHIDE CHANNELS ON THE REMOTE (optional)

Hide Unused Channels On The Remote

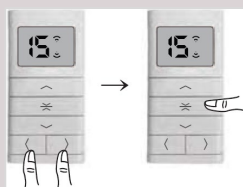

Step 1. Press and hold both **Left** and **Right** buttons at the same time until you see "**C**" and then "**15**" on the screen. Then release the buttons.

Step 2. Click the **Left** or **Right** button to select how many channels you want to keep on the remote. For example, if you have **5** motorized shades connected to this remote, please select "**5**".

Step 3. Press and hold the **My Favorite** button (a small square "" will appear first) until the channel number is shown on the screen again.

Hide Unused Channels Setting is done.

Unhide Unused Channels On The Remote

Step 1. Press and hold both **Left** and **Right** buttons at the same time until you see "**C**" and then "**15**" on the screen. Then release the buttons.

Step 2. Press and hold the **My Favorite** button until a small square "" is shown on the screen.

Unhide Setting is done.

Simple Touch® 15-Channel Remote Cellular Shade

In the rare instance that you need to reverse the motor, reset the limits, remove all connected remotes, or connect a remote to the motor, follow the steps below.

TO REVERSE THE MOTOR DIRECTION.

Reverse the motor

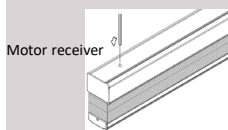

Step 1. Click the **Up** button and then click the **My Favorite/ Stop** button. (no jogs or beeps, just click each then proceed to Step 2.)

Step 2. Press the **Motor Receiver** button with a paper clip and don't release it until the shade **jogs** twice.



TO RESET THE UPPER LIMIT, LOWER LIMIT, AND MY FAVORITE POSITION.

Reset the limits.



Press the **Up**, **My Favorite**, and **Down** buttons at the same time. Don't release until you hear a long "B".

This step will erase all 3 limits.



Continue to follow the instructions below to set up the **Upper Limit** and **Lower Limit**.

Set Upper Limit



Step 1. Press the **Up** button to control the bottom rail going up.

Step 2. Press the **Up & My Favorite/ Stop** buttons at the same time for around 5 seconds until you hear 3 short "B".

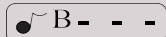

Upper Limit set up is done.

Set Lower Limit



Step 1. Press the **Down** button to control the bottom rail moving down until it reaches the ordered drop height.

Step 2. Press the **Down & My Favorite/ Stop** buttons at the same time for around 5 seconds until you hear 3 short "B".

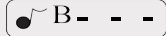

Lower Limit is done. Enjoy your motorized shade.

TO REMOVE ALL CONNECTED REMOTES.

Delete A Duplicated Remote Control

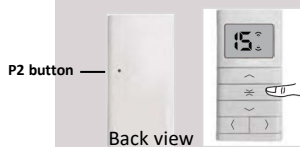

Step 1. Click the **P2** button with a paper clip once on one of the remotes. Wait for the shade to "**jog**".



Step 2. Click the **My Favorite** button, and then wait for another **jog**.

Step 3. Click the **P2** button on the same remote again, and then the shade will jog.

All remotes will be disconnected after these steps. NOTE - THE SHADE CAN NO LONGER BE CONTROLLED BY ANY REMOTE.

INITIAL PROGRAM THE MOTORIZED SHADE (CONNECT THE REMOTE TO THE MOTOR), PLEASE FOLLOW THE STEPS BELOW.

Frequency Connection (The RF box is inside of the headrail)

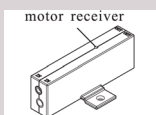
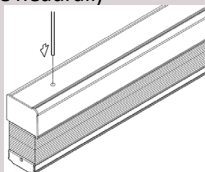

Step 1. Select the channel on the remote with clicking the **Left Arrow** and/ or **Right Arrow** buttons.

Step 2. Press the **Motor Receiver** button with a paper clip for 2 seconds, the motor **jogs** once, and then release the **Motor Receiver** button.



Step 3. Click the **P2** button (on the back side of the remote) with a paper clip, and then wait for the motor to "**jog**".



Step 4. Click the **P2** button again and wait for another "**jog**".

Step 5. Click the **Up** button (on the front side of the remote).

Frequency Connection completed.

NOTE – THE STEP "FREQUENCY CONNECTION" IS TO CONNECT THE REMOTE TO THE MOTOR.

Follow above steps "**Set Upper Limit**" and "**Set Lower Limit**" to set up the limits.

Simple Touch® 15-Channel Remote Cellular Shade



FCC ID# 2AWSE-STP017WR15

FOR INDOOR USE ONLY

This motorized shade has been tested and found to complete with the limits for a Class B digital device, pursuant to part 15 of the FCC rules. These limits are designed to provide reasonable protection against harmful interference in a residential installation. This shade generates, uses and can radiate radio-frequency energy. If this shade is not installed and used in accordance with the instructions, it may cause harmful interference to radio communications. However, there is no guarantee that interference will not occur in a particular installation. If this shade does cause harmful interference to radio or television reception, which can be determined by turning the shade off and on, correct the interference by one or more of the following measures:

Reorient or relocate the receiving antenna.

Increase separation between shade and receiver.

Connect equipment to an outlet on a circuit different from that to which the receiver is located.

Consult your dealer or an experienced radio/TV technician.

Any changes or modifications to the product that are not expressly approved by HT could void the user's authority to operate this shade. Use of a shielded interface cable is required to comply with the Class B limits of Part 15 of FCC rules. For more regulatory information, see the electronic user guide. HT shall not be liable for any direct, indirect, incidental, consequential, or other damage alleged in connection with the furnishing or use of this information.